



Filter system for optimising drinking water

Installation and operating instructions **EN**

BWT bestaqua 14ROC

Installation and operating instructions

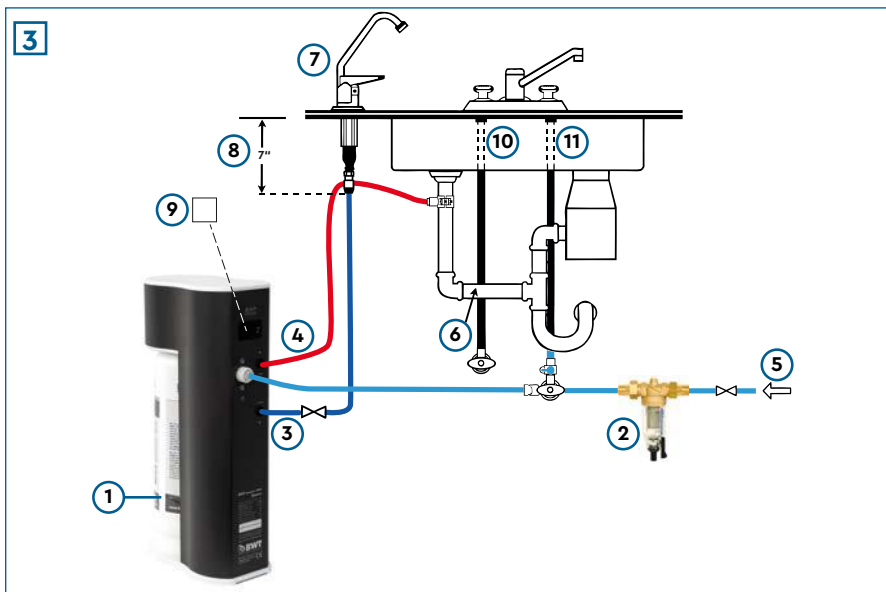



Table of Contents

1	Introduction and safety	4
1.1	Abbreviations and subject index	4
1.2	Scope of delivery	4
1.3	Manufacturer's address	4
1.4	General information	5
1.4.1	Reading the installation and operating manual (IOM)	5
1.4.2	Warranty and disclaimer	5
1.4.3	Responsibilities of the operator	5
1.4.4	Licensing conditions	5
1.4.5	Description of symbols listed	5
1.5	Operator and safety notes	6
1.5.1	Proper use	6
1.5.2	Correct operating method	6
1.6	Description of process	7
1.7	Installation requirements	7
1.7.1	Site installation requirements	7
1.7.2	Feedwater requirements	7
1.7.3	Operating pressure	7
2	Installation and assembly	8
3	Operating the reverse osmosis unit	9
3.1	Switching on the RO device	9
3.2	Setting the water quality using the blending function	9
3.3	Hygiene concept and stoppages	9
3.4	Removing/replacing the RO cartridge	10
3.5	Instructions for installing and operating the BWT bestaqua 14ROC app	10
3.5.1	Installing the app	10
3.5.2	Connecting your smartphone with the ROC using the app	11
3.5.3	Using the app	11
3.5.4	Settings in the service menu	12
3.5.5	Fault messages	14
4	Troubleshooting	14
4.1	Overview of the status and alert LED	14
4.2	Fault correction	14
5	Repairs and maintenance	15
5.1	Maintenance and wearing parts	15
5.2	Cleaning	15
5.3	RO cartridge replacement	16
5.4	Disposal	16
5.5	Standard IEC 60335-1	16
5.6	Technical data BWT bestaqua 14ROC	16

1 Introduction and safety

1.1 Abbreviations and subject index

Softening:	The water purification process removes the hardness from raw water. Hardness constituents are the portion of calcium and magnesium ions in the water.
Raw water:	Raw water (usually untreated drinking water) must be pre-treated (usually softening) before it can be used in the RO device.
RO:	reverse osmosis.
Permeate:	"Pure water" that has been largely desalinated by reverse osmosis. The characteristic value is the electric conductivity in $\mu\text{S}/\text{cm}$ or TDS.
Concentrate:	Waste water containing the salts and minerals that have been removed from the raw water.
Membrane:	The "filter" of the device which is capable of desalinating the raw water by high pressure and flow.
TDS:	Total Dissolved Solids: the total amount of dissolved salts, measured in mg/l .
SDI:	Silt Density Index: A measure of the blockage tendency of water.
Electrical conductivity	The smaller the value of the electrical conductivity measured (in $\mu\text{S}/\text{cm}$) by the RO device, the lower the salt concentration in the permeate product.
IOM:	Installation and Operating Manual
Permeate yield (WCF):	The ratio between the purified water produced (permeate) and the amount of feed water (soft water) required to do so is expressed as permeate yield (WCF) or "Water Conversion Factor".
Bypass setting with cold drinking water:	Using the bypass setting on the blue regulation/mixing head (at the top of the device underneath the service cover), a set proportion of the unfiltered raw water can be mixed into the purified water. See paragraph 3.2 for the suitable bypass settings (1, 2 or 3) for the various household applications.

1.2 Scope of delivery

The reverse osmosis device is supplied with the following:

- 1 RO cartridge
- 2 Device ON/OFF switch
- 3 Permeate connection 5/16"
- 4 Concentrate connection 5/16"
- 5 Feedwater connection 3/4" (for 6 mm hose)
- 6 Top service cover for blending valve (initial setting "0")
- 7 Bottom service cover for attaching/detaching the RO cartridge

Optionally available:

- 1b RO replacement cartridge (item no. 812835)

1.3 Manufacturer's address

BWT water + more GmbH

Walter-Simmer-Straße 4

5310 Mondsee, Austria

Telephone: 01494 838 100

Fax: 01494 838 101

E-mail: enquiries@bwt-uk.co.uk

1.4 General information

This installation and operating manual (IOM) contains important instructions for safe and efficient use of the reverse osmosis device BWT bestaqua 14ROC. This installation and operating manual (IOM) is part of the device and must be constantly available at the place of operation for all staff members assigned.

1.4.1 Reading the installation and operating manual (IOM)

The staff must have read and understood this IOM prior to any work being carried out. A basic precondition for safe working is the adherence to all stated safety and operating instructions. In addition, the local accident prevention provisions and the general safety provisions effective at the place of operation are applicable. The illustrations in these instructions are intended to provide a basic understanding and may deviate from the actual design of the device. Justified claims cannot be derived from the same.

1.4.2 Warranty and disclaimer

▽ ATTENTION!

- ▶ The information and instructions contained in this Installation and Operating Manual are compiled based on current standards and regulations, the state of the technology, and our many years of experience and observation.

The warranty is void in any of the following cases:

Failure to follow the provisions and information in this IOM

Improper use

Improper or faulty installation

Improper start-up, operation or maintenance

Use of non-approved components or non-original parts

Neglecting to perform the required service and replacement tasks

Technical modifications: damage, faults and stoppages resulting from unauthorised alterations

1.4.3 Responsibilities of the operator

The installation and operating manual (IOM) must be easily accessible and kept in the immediate vicinity of the device.

The device must be operated in a technically faultless and operationally safe condition only.

The provisions in the IOM are to be followed absolutely.

1.4.4 Licensing conditions

This IOM is protected by copyright law. Surrendering the manual to any third party, duplication of any kind and form – also in excerpts – as well as the utilisation and/or communication of the content are not permitted without the written consent of the manufacturer. Infringements obligate to pay compensation for damages. Further claims are reserved.

1.4.5 Description of symbols listed

⚠ DANGER!

- ▶ Electric current or voltage! Always consult a qualified electrician when working on places denoted by this symbol.

⚠ CAUTION!

- ▶ Details to avoid personal injury or extensive damage to property.

▽ ATTENTION!

- ▶ Underlines useful recommendations and information for an efficient operation free of any interruptions.

📘 NOTE!

- ▶ Additional operator information.

1.5 Operator and safety notes

This section gives an overview of all operational and safety aspects important for ensuring safe and fault-free operation. Despite all possible precautionary measures, some residual risk remains with any product, especially if it is used incorrectly. Warranty claims are void unless the provisions in this IOM are observed and followed.

1.5.1 Proper use

This device is for desalination of drinking-quality water at up to 30 °C and 0.4 MPa (4 bar). It can be used either with or without an atmospheric pressure tank (application dependent). Consult your dealer about installation recommendations.

▽ ATTENTION!

- ▶ The inflow water must not exceed the limit values given in the technical data or the calcium solubility limit in paragraph 5.6!
- ▶ The device shall only be used for its intended purpose as designed and as described here in this manual. Any other use is considered "improper".

⚠ CAUTION!

- ▶ The RO unit must be fed with cold water in drinking water quality.
- ▶ Claims for damages resulting from improper use are void.

1.5.2 Correct operating method

▽ ATTENTION!

- ▶ To protect the drinking water, observe the country-specific guidelines for drinking water installations in any work on the RO device.
- ▶ Incorrect installation of the RO device may cause damage.

The device must be disconnected prior to performing any maintenance work on the drinking water supply. Rinse the water pipe sufficiently before reconnecting the device. Before installation, disconnect the device and any terminal devices from the power (pull the mains plug).

⚠ CAUTION!

- ▶ In some countries the desalinated water (permeate) produced must not be used for drinking. Observe country-specific regulations.

Observe any country-specific installation regulations (such as DIN 1988, EN 1717,), general hygienic conditions and technical data for protecting the drinking water.

Unauthorised modifications to the RO device and technical alterations are not permitted. Avoid mechanical damage to the device which may void the warranty.

Install a stop valve upstream of the RO device.

Connect the device only using flexible hoses that conform to local plumbing regulations (e.g. DVGW W 543).

The device should not be installed in the vicinity of heat sources or open flames.

The RO device should not come into contact with chemicals, solvents, or vapours.

The installation site must be free of frost and protected from direct sunlight.

The device is not to be operated with feedwater that is microbially unsafe or whose origin is of unknown quality.

When the RO device is used for food applications, all permeate lines must be cleaned and rinsed thoroughly before use.

Avoid leaving the device in storage for a long time in order to reduce the risk of idle contamination. The system must be cleaned and sanitised before use.

1.6 Description of process

The semi-permeable reverse osmosis membrane separates the raw water, which is supplied under high pressure (approx. 8 bar), into desalinated purified water (permeate) and the salty waste water (concentrate).

The percentage ratio between the permeate produced and the amount of raw water used is called the WCF yield (%). The RO device is factory-configured for a WCF of approximately 50%.

On/off control points:

Automatic RO operation via pressure switch: 1.5 and 4.0 bar.

Note that pressure fluctuations may lead to the device switching off.

Once the connected consumer starts drawing purified water, the actual pressure drops below the set "RO starting pressure" and the RO unit starts producing water automatically.

1.7 Installation requirements

1.7.1 Site installation requirements

Choose a place to set up the device that allows simple connection to the water supply network. There should be a wastewater connection and a separate mains connection (100–230 V, 50 Hz) in the immediate vicinity. The device must be electrically connected to a grounded mains socket. The voltage supply and the required feedwater pressure must be stable.

National guidelines and regulations:

Please observe the general standards, guidelines and technical data.

Frost protection and pre-treated water:

The installation site must be free of frost and kept free of chemicals, paint, solvents and fumes. If the municipal water supply is treated with oxidising disinfectants (such as chlorine, chlorine dioxide, or similar), then an activated carbon filter must be installed upstream of the device and changed regularly. Further pre-treatment may be necessary depending on the feedwater quality.

Quality of the supply pipeline:

▽ ATTENTION!

▶ All components in contact with permeate water should be corrosion resistant.

Electrical interference:

Interference emissions (voltage peaks, high-frequency electromagnetic fields, spurious and voltage oscillations, etc.) of the surrounding electrical installation must not exceed the maximum values set in the standard EN 61000-6-4.

1.7.2 Feedwater requirements

The water fed into the device must be cold water that conforms to the statutory drinking water requirements and the water quality requirements in table 5.6.

Analysis of the local feedwater:

Any deviation from proper use, such as desalination of feedwater of impermissible quality (non-drinking water), may result in irreversible damage to health or property (e.g. microbial contamination of the RO device).

1.7.3 Operating pressure

For optimal functioning, the device requires a minimum operating pressure. In addition, the water pressure should not exceed the maximum permissible pressure.

▽ ATTENTION!

▶ The feedwater pressure must always be between 0.15 and 0.4 MPa (1.5 and 4.0 bar) as measured directly at the RO unit.

CAUTION!

- ▶ If the pressure exceeds 0.4 MPa (4.0 bar), then a pressure reducing valve must be installed.
- ▶ If the pressure drops below 0.15 MPa (1.5 bar), then a pressure booster system must be installed upstream.

We recommend installing a shut off valve at the inlet side of the device to enable the feed-water flow to be interrupted for service purposes. Installation should use at least DN 10. Smaller feed pipes may result in operational stoppage due to insufficient water pressure or flow (e.g. when flushing the reverse osmosis membranes).
Installing a pressure reducer may reduce the flow rate.

2 Installation and assembly

Unpacking the RO device:

Remove the device from the packaging and check that all components are included and undamaged.

Hydraulic installation:

ATTENTION!

- ▶ Observe the general installation regulations for creating water installations and the general hygiene conditions.

Read the technical data, operating notes, and safety notes first and observe them during installation.

Use only flexible hoses approved under DVGW W 543 to connect the device.

Observe the installation dimensions and bend radii when installing accessories (such as hoses, connection sets, etc.).

The device bestaqua 14ROC is to be set up and operated with installed magnet plates.

The device may not be hard plumbed to the water supply network, e.g. copper or brass.

Connecting to the water pipe:

The hoses of the device are to be connected free of tension.

Verify that connections are watertight.

The concentrate line is to be connected to the wastewater connection with an approved air gap. Check that flexible hoses are free of any restrictions. During installation, ensure that the concentrate and permeate lines are correctly connected.

NOTE!

- ▶ Before using the RO unit, we recommend checking the water pre-treatment (e.g. in-house softener, central water processing of waterworks). This measure is necessary to improve the efficiency and service life of your RO membrane.
- ▶ Please discard the permeate produced during the first ten minutes after installation, initial start-up, or membrane change.
- ▶ Reduction of the temperature by 1 °C results in a reduction of the permeate output of the membranes by approximately 3 %.

Connect the RO device to a grounded mains socket (100–230 V, 50 Hz).

Please observe the provisions in the operating manual of the external pre-filter used.

As a general rule, we recommend using softened water to extend the service life and operational safety of the RO membrane.

Connect all hoses and check for water leaks.

Open the inlet valve for the feedwater supply.

Connect the mains plug (230 V/50 Hz) to the power supply.

⚠ DANGER!

- ▶ Always disconnect the voltage supply of the unit by removing the plug or fuse if hard wired during any maintenance and electrical work.

Installation suggestion:

- 1 BWT bestaqua 14ROC Reverse Osmosis
- 2 Particle pre-filter (not included in delivery but recommended to protect the RO membrane)
- 3 Permeate connection 5/16" push-fit
- 4 Concentrate connection 5/16" (for connection to the drain)
- 5 Feedwater inlet 3/4"
- 6 Alternative position for the drain connection
- 7 Water tap
- 8 Observe: 7" installation height
- 9 PE mains plug type IEC 320
- 10 Hot feed water
- 11 Cold feed water

3**⚠ CAUTION!**

- ▶ The RO device must be operated using only cold water that meets the legal requirements for potable water.

3 Operating the reverse osmosis unit

3.1 Switching on the RO device

The RO device must be connected to the hoses and the electrical socket.

Use the device switch (situated on the rear of the device) to switch on the BWT bestaqua 14ROC. A green LED indicates that the RO unit is switched on.

4

3.2 Setting the water quality using the blending function

▽ ATTENTION!

- ▶ The standard setting on the filter head is 0, i.e. no blending.

Integrated blending can be used to increase the conductivity of the permeate by mixing it with feedwater. Whether this is necessary depends on the end application. If needed, the blending setting (bypass mixing of feedwater) can be set to 1, 2 or 3.

The blending head is situated underneath the top cover plate. Press the blue button to facilitate changing of the bypass setting. Turn the blending head while keeping the blue button pressed to change the setting to 1, 2 or 3. Higher settings (1, 2 and 3) correspond to higher proportions of feedwater (25%, 50% and 75%) being blended in.

5**ⓘ NOTE!**

- ▶ Blending allows untreated water into the permeate water.

3.3 Hygiene concept and stoppages

There are two hygiene concepts designed to ensure the maximum service life of the membranes.

Stop delay: After each production run, the pump continues to run for approx. 10 s to rinse the membrane with tap water. This ensures that the conductivity on the concentrate side of the membrane falls back down to the inlet conductivity. This avoids stagnation peaks and reduces calcification of the membrane. The volume of waste water generated by this process is approx. 330 ml.

Interval flushing: If the device is not operated for extended periods (at weekends etc.), the membrane is automatically rinsed every three hours. The inlet solenoid valve opens for approx. 30 s and the membrane is rinsed with pipeline pressure. Depending on the pipeline pressure, the volume of waste water generated by this process is between 300 and 700 ml.

If the RO is out of service for a longer period of time (for example, during holidays), it is necessary to rinse the device for five minutes. The flush water must be discarded to drain.

NOTE!

- ▶ Please observe the provisions in the operating manual of the external pre-filter used.

3.4 Removing/replacing the RO cartridge

6

Before removing the RO cartridge, shut off the feedwater supply. In addition, disconnect the mains plug and ensure that the "Power-On LED" is no longer illuminated.

Please unscrew the old RO cartridge by tipping the RO device back slightly and then unscrewing the old, depleted RO cartridge by turning it anti-clockwise.

7

Then screw in the new RO cartridge. Ensure that the opening in the tip of the RO cartridge is fitted precisely concentrically to the feed plug.

8

The RO cartridge should normally be replaced every 12 months, but the correct interval may vary depending on the raw water quality.

NOTE!

- ▶ After each RO cartridge change, run the device for 10 minutes to rinse the new cartridge. Please note the internal pre-pressure setting of 2.0 bar.



3.5 Instructions for installing and operating the BWT bestaqua 14ROC app

3.5.1 Installing the app



If you have not yet installed the BWT bestaqua 14ROC app, please scan the QR code below. This will take you to the website from which you can download the app.





3.5.2 Connecting your smartphone with the ROC using the app

		
<p>Select the device from the list (in this case: 14ROC with the ID number A4:34:F1:AA:F2:00). If multiple devices are present, select the unit number which corresponds with the 14ROC serial number. Please attach a screenshot to the log!</p>	<p>Once the RO unit is selected, the screen below will be displayed. The LED on the front of the bestaqua 14ROC will light up blue.</p>	<p>Once a connection to the device has been established, the screen below will be displayed. The device is ready for permeate production. The app shows "ready".</p>

3.5.3 Using the app

	 <table border="1" data-bbox="530 766 710 1078"> <tr> <td>012 µS</td> <td>18.2 °C</td> </tr> <tr> <td>CONDUCTIVITY</td> <td>FEED TEMP.</td> </tr> <tr> <td>2.5 bar</td> <td>186 DAYS</td> </tr> <tr> <td>OUTLET PRESS.</td> <td></td> </tr> <tr> <td>01560 hr</td> <td>0016 hours</td> </tr> <tr> <td>INLET WATER</td> <td>PUMP ON</td> </tr> <tr> <td>03340 hr</td> <td>095 hours</td> </tr> <tr> <td>OUTLET WATER</td> <td>OUTLET FLOW</td> </tr> </table>	012 µS	18.2 °C	CONDUCTIVITY	FEED TEMP.	2.5 bar	186 DAYS	OUTLET PRESS.		01560 hr	0016 hours	INLET WATER	PUMP ON	03340 hr	095 hours	OUTLET WATER	OUTLET FLOW	
012 µS	18.2 °C																	
CONDUCTIVITY	FEED TEMP.																	
2.5 bar	186 DAYS																	
OUTLET PRESS.																		
01560 hr	0016 hours																	
INLET WATER	PUMP ON																	
03340 hr	095 hours																	
OUTLET WATER	OUTLET FLOW																	
<p>When the consumer is drawing permeate, the app shows the status "working" with a blue spinning circle. The reverse osmosis unit now produces permeate water.</p>	<p>During operation, this screen can be displayed to the customer when the "working" button is pressed. The system data is displayed as follows.</p> <ul style="list-style-type: none"> ▶ Conductivity in TDS or µS (configurable in the menu) ▶ Temperature of the feed-water ▶ Output pressure in bar ▶ Running time in days ▶ Amount of water at the infeed ▶ Pump running time in hours ▶ Amount of permeate produced ▶ Permeate flow rate 	<p>After the consumer stops drawing permeate or if the atmospheric tank is full, the system flushes the membranes with raw water (approx. the bed volume of the cartridge). If no permeate is drawn, the system flushes with feedwater every 3 hours.</p>																

	
<p>The following message in the main menu indicates that the unit needs servicing. The procedure for resetting the service indicator is described in Section 3.4.4.</p>	<p>If a YELLOW CIRCLE is shown while permeate is being drawn, this means that the WCF¹ ALERT has been triggered. This means the WCF is lower than 30 or 40 percent. The WCF warning value can be configured in the service menu.</p>

3.5.4 Settings in the service menu

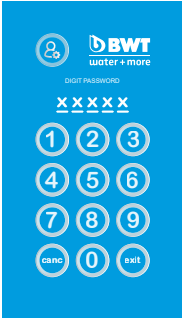
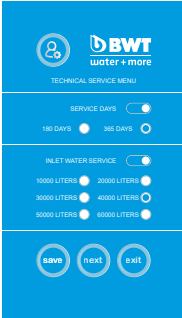
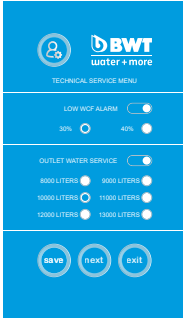
		
<p>Enter the password to access the service menu.</p> <p>PASSWORD: 05310 Basic information on navigating the service menu</p> <ul style="list-style-type: none"> ▶ Each time a value is modified, press the "save" button and wait for an audible signal from the device. ▶ Press the "next" button to proceed to the next screen. ▶ Press the "exit" button to leave the service menu and return to the "ready" screen. 	<p>Configuration menu for service days (default: every 365 days) and the pre-filter (activated carbon, particle filter, etc.)</p> <ul style="list-style-type: none"> ▶ Select option with slider ▶ Set required value ▶ Press "save" and wait for an audible signal! ▶ Press "next" 	<p>Settings for WCF alert and permeate polishing filter (postfilter) This filter can re-mineralise!</p> <ul style="list-style-type: none"> ▶ Select option with slider ▶ Set required value ▶ Press "save" and wait for an audible signal! ▶ Press "next"

¹ W.C.F. = Water Conversion Factor: the proportion of permeate to feedwater in percent

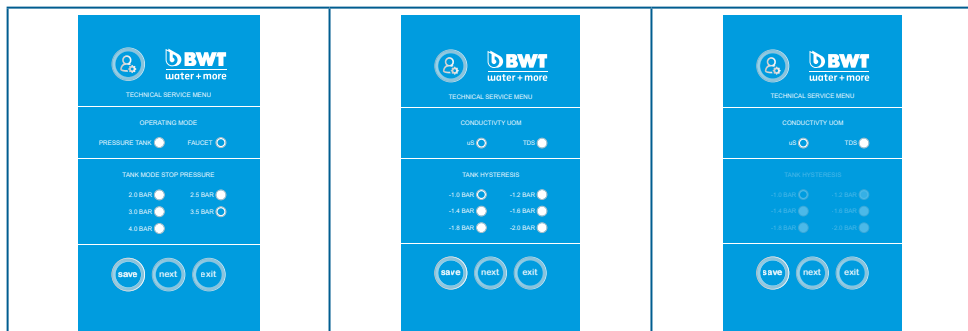

Setting for operating with a pressure tank OR UTS* operation (FAUCET).

In tap mode, no shut-off pressure is available!

In pressure tank mode, the following shut-off pressure levels are available.

2.0 bar / 2.5 bar / 3.0 bar / 3.5 bar / 4.0 bar

Note: In operation, the shut-off pressure will briefly exceed the set value. This is normal.

Settings for conductivity reading in the main menu (TDS or $\mu\text{S}/\text{cm}$) and pressure tank hysteresis

(shut-off pressure - hysteresis = switch-on pressure of the RO unit)

Note: The hysteresis should be between 1.6 and 1.8 bar to minimise the switching cycles of the pump. This affects the service life of the pump and the membrane!



Settings for service resets:
All counters can be reset!

The pump operating time counter is secured with a password to prevent it from being reset accidentally!





Once the "save" button is pushed and an audible signal sounds, the desired values are reset.

The reset history list shows which parameter was reset on which day (date).

SOFTWARE RELEASE:	HQLTV1.0
APP RELEASE:	THERV1.0

Software release: Current firmware in the device.
App release: Current version of the smartphone app.
The software and the app must have the same release in order for the RO device to function correctly.

3.5.5 Fault messages

 <p>BWT bestaqua 14ROC</p>	 <p>BWT bestaqua 14ROC</p>	 <p>BWT bestaqua 14ROC</p>	 <p>BWT bestaqua 14ROC</p>	 <p>BWT bestaqua 14ROC</p>
<p>System losing pressure in "Tap" mode, or permeate line leaks. Switch off device. Check for and repair leaks. Switch the unit back on.</p>	<p>Leakage in the device itself! This may be caused by either a leak or excessive ambient humidity. Switch off the device. Check and repair any leaks.</p>	<p>Possible causes:</p> <ul style="list-style-type: none"> ▶ Inlet water pressure too low ▶ Inlet water line closed off ▶ Potential inlet water lead compromising water pressure 	<p>Running time of the pump exceeded, bi-metallic switch triggered. Thermal overload protects pump. Pump will cool before switching on.</p>	<p>Please report this to BWT. Include a screenshot of the log file!</p>

4 Troubleshooting

4.1 Overview of the status and alert LED

Status and alert:	LED colour:	Description of the device status:
working (production)	Green / illuminated	RO device produces permeate (purified water) / POWER ON
working (production)	Yellow / illuminated	WCF alert triggered
working / bluetooth connected	Blue / illuminated	Mobile device connected to RO via Bluetooth
working / bluetooth connected	Blue / flashing	Bluetooth connection interrupted
Fault	Red / flashing	Fault message according to display in app

4.2 Fault correction

Possible cause:	Fault correction:
<ul style="list-style-type: none"> ▶ No raw water feed since the shut off valves in the inlet are closed. ▶ The external pre-filter/particle filter is blocked ▶ Faulty power cable 	<ul style="list-style-type: none"> ▶ Check the shut off valves and open if necessary; check the flow pressure (working range of the RO unit: 1.5 to 4.0 bar) ▶ Check pre-filter and replace if necessary ▶ Observe the provisions in the operating manual of the external pre-filter ▶ Replace faulty mains plug (ensure that the green LED is lit steadily) ▶ Inform customer service
<ul style="list-style-type: none"> ▶ Water leaking inside the device or RO cartridge not screwed in completely 	<ul style="list-style-type: none"> ▶ Disconnect devices from power and water supply ▶ Screw in RO cartridge hand-tight (using two hands is too tight and not necessary) ▶ Inform customer service
<ul style="list-style-type: none"> ▶ Pump doesn't start or is audibly louder 	<ul style="list-style-type: none"> ▶ Pump faulty (overheating) ▶ Pump fuse faulty (overheating) ▶ Inform customer service

▽ ATTENTION!

- ▶ In the event of a fault in the RO device, there is no alert signal. Before the RO device is exchanged, the following causes must be checked and forwarded to customer service.

5 Repairs and maintenance

5.1 Maintenance and wearing parts

You have purchased a product that is durable and easy to service. However, all technical equipment requires regular servicing so that it continues to function properly.

If the product malfunctions during the warranty period, contact your contract partner or the installation company, and quote the unit type and serial number (see technical specifications or the type plate on the unit).

Wearing parts must be replaced within the prescribed maintenance intervals.

▽ ATTENTION!

- ▶ To maintain correct functioning and optimal water quality, the unit must be maintained at regular intervals (at least once per year) by an authorised service technician.
- ▶ Please observe the provisions in the operating manual for the installed external pre-filter.
- ▶ Before performing work on electrical components or opening the housing, it is mandatory that the mains plug be pulled and both the water infeed and the permeate line be closed off in order to guarantee that the unit is voltage-free.
- ▶ Whenever maintenance is performed, the connection lines and the device must be checked for damage.

📘 NOTE!

- ▶ Only customer service may replace the wearing parts (e.g. after a faulty pump).

Replacement of wearing parts:

Maintenance work:	Responsible:	Recommended maintenance interval:
General visual inspection	Customer	Weekly
Leak inspection	Customer	Weekly
Cleaning with a damp cloth	Customer	As necessary
Operating pressure between 2.0 and 4.0 bar	Customer	Weekly
Conductivity (with external measuring device)	Customer/service	At least once per year
Replacement of the external pre-filter insert (carbon/particle filter (optionally available))	Customer/service	Depending on the pre-filter used
Replacement of the RO cartridge	Service	Once per year (recommended)
Water hardness test	Service	At least once per year

▽ ATTENTION!

- ▶ In accordance with BVG A3 (VBG4), the unit must be tested for electrical safety every 4 years.
- ▶ The BWT bestaqua 14ROC reverse osmosis unit is subject to the Pressure Equipment Directive 2014/68/EU from 27 Jun 2014. The RO unit fulfils the requirements set forth in article 3, section 3, and was designed and manufactured according to the applicable engineering good practices.
- ▶ The BWT bestaqua 14ROC device does not have a CE mark according to article 6, section 5, of the directive 2014/68/EU, but the attached CE Declaration of Conformity is valid.

5.2 Cleaning

Clean the reverse osmosis unit with a damp cloth and a mild cleaning agent.

To protect the surfaces of the device, do not use alcohols, bleach or solvents.

5.3 RO cartridge replacement

If the permeate flow rate drops off or the conductivity of the permeate rises, the membrane element must be replaced. Furthermore, we recommend replacing the membrane every 12 months. Further information on replacing the RO cartridge can be found in paragraph 3.3.

5.4 Disposal



Procedure: The BWT bestaqua 14ROC consists of various materials which need to be disposed of properly.

Please contact your contract partner for an expert and environmentally friendly disposal. Please do not dispose of depleted batteries in general household waste.



Any electronic parts should be disposed of only at authorised recycling centres (2012/19/EU). Observe the applicable national regulations on disposal of electric devices.

5.5 Standard IEC 60335-1

This device is not intended to be operated by persons not in possession of full physical, sensory and mental faculties (including children) nor by persons without relevant experience or knowledge. Prior to using the device, personnel must be instructed in its use and given clear operating instructions by an expert specialist.

The device is to be secured against access by children.

To avoid hazards, in the event of any damage to the power cable, it must be replaced by the manufacturer, a service partner of the manufacturer or a similarly qualified person.

Please visually inspect the water hoses for damage (see paragraph 5.1).

5.6 Technical data BWT bestaqua 14ROC

Technical data BWT bestaqua 14ROC		
Permeate production ^{*1)} (produced)	l/min (l/h)	2 l/min (120 l/h)
Salt retention rate	%	> 97
Water conversion factor WCF (factory setting) ^{*2), *3)}	%	approx. 50%
Feedwater flow rate	l/min (l/h)	min. 4.2 l/min; min. 250 l/h
Concentrate (only while operating)	l/min (l/h)	approx. 2.0 l/min; approx. 120 l/h
Feed water pressure	MPa (bar)	0.15–0.4 MPa (1.5– 4.0 bar)
Feedwater, ambient temperature (min./max.)	°C	5 – 30 / 5 – 40
Iron + manganese (Fe+Mn)	mg/l	< 0.05
Silicate (SiO ₂)	mg/l	< 15
Salt level, Total Dissolved Solids (TDS)	mg/l	< 500
Silt Density Index (SDI)	%/min	< 3
Oxidants	mg/l	< 0.05
Protection class	IP	54
Electrical connection / fuse / internal fuse	V/Hz/A	230 / 50 / 10 / 1.25 A (Type T / "slow burn")
Electrical power consumption (operation/standby)	W	200 / < 3
Plug standard (grounded PE mains plug)		IEC-320 socket
Feedwater, permeate and concentrate connections	Inches/inches/inches	3/4"; 5/16"; 5/16" JG
Dimensions: Width, depth, height (W×D×H)	mm	152 × 254 × 508
Weight	kg	11
Order numbers:		821039 / RS81M01A00

*1) The actual nominal flow rate may deviate slightly from the flow rate indicated in the table due to fluctuations in the feedwater quality, the flow pressure, the water temperature, and the permeate counter-pressure (e.g. with great permeate pumping heights).

*2) As a general rule, the manufacturer recommends pre-treating the feedwater.

*3) The RO device is factory-configured for a WCF of about 50%.



BWT UK Limited

BWT House, The Gateway Centre,
Coronation Road, High Wycombe,
Buckinghamshire, HP12 3SU

Telephone: 01494 838 100

Email: enquiries@bwt-uk.co.uk

www.bwt-uk.co.uk

